

Canon

RF

24-105mm F2.8 L IS USM Z

Instructions

ENG

Thank you for purchasing a Canon product.

Canon RF24-105mm F2.8 L IS USM Z is a large aperture standard zoom lens for use with EOS R series cameras.

- “IS” stands for Image Stabilizer.
- “USM” stands for Ultrasonic Motor.

Conventions used in these instructions



Warning to prevent lens or camera malfunction or damage.



Supplementary notes on using the lens and taking pictures.

Camera Firmware and Camera Applications

Please use the latest versions of firmware and applications with the camera in use. For details on whether the firmware and applications in use are the latest version or not, and for details on updating them, please check the Canon website.



If the camera's* firmware is not a compatible version, the following limitations will apply.

- Magnified view functionality is not available.
- In some cases, the camera malfunction may occur.

* Applies to the following camera models:
EOS R and EOS RP

Safety Precautions

Precautions to ensure that the camera is used safely. Read these precautions thoroughly. Make sure all details are observed in order to prevent risks and injury to the user and other people.



Warning

Details pertaining to risks that may result in death or serious injury.

- **Do not look directly at the sun or other strong light sources through a lens.** This may result in loss of sight.
- **Do not leave a lens in the sun without the lens cap attached.** The lens may concentrate entering sunlight and cause a malfunction or fire.



Caution

Details pertaining to risks that may result in injury or damage to other objects.

- **Do not leave the product in places exposed to extremely high or low temperatures.** The product may cause burns or injury when touched.
- **Do not insert your hand or fingers into the product.** This may result in injury.
- **When using a tripod, please use one that has sufficient strength.**
- **Make sure that the tripod mount knob is firmly tightened.**
- **When carrying the lens with the tripod mount attached, ensure that the tripod mount knob is securely tightened, and take care when carrying.** Not doing so may result in the product falling off, leading to damage or injury.

General Precautions

Handling Precautions

- Do not leave the product in excessive heat such as in a car in direct sunlight. High temperatures can cause the product to malfunction.
- If the lens is taken from a cold environment into a warm one, condensation may develop on the lens surface and internal parts. To prevent condensation in this case, first put the lens into an airtight plastic bag before taking it from a cold to warm environment. Then take out the lens after it has warmed gradually. Do the same when taking the lens from a warm environment into a cold one.
- In order to optimize aperture control, there are occasions in which the diaphragm blades will move during zooming and focusing, even when the aperture value is set for aperture priority AE or manual exposure, etc.
- Please also read any lens related handling precautions listed in your camera's instruction manual.

This device complies with Part 15 of the FCC Rules.

Operation is subject to the following two conditions: (1) This device may not cause harmful interference, and (2) this device must accept any interference received, including interference that may cause undesired operation.

Do not make any changes or modifications to the equipment unless otherwise specified in the instructions. If such changes or modifications should be made, you could be required to stop operation of the equipment.

This equipment has been tested and found to comply with the limits for a class B digital device, pursuant to part 15 of the FCC Rules. These limits are designed to provide reasonable protection against harmful interference in a residential installation. This equipment generates, uses and can radiate radio frequency energy and, if not installed and used in accordance with the instructions, may cause harmful interference to radio communications.

However, there is no guarantee that interference will not occur in a particular installation. If this equipment does cause harmful interference to radio or television reception, which can be determined by turning the equipment off and on, the user is encouraged to try to correct the interference by one or more of the following measures:

- Reorient or relocate the receiving antenna.
- Increase the separation between the equipment and receiver.
- Connect the equipment into an outlet on a circuit different from that to which the receiver is connected.
- Consult the dealer or an experienced radio/TV technician for help.

Nomenclature

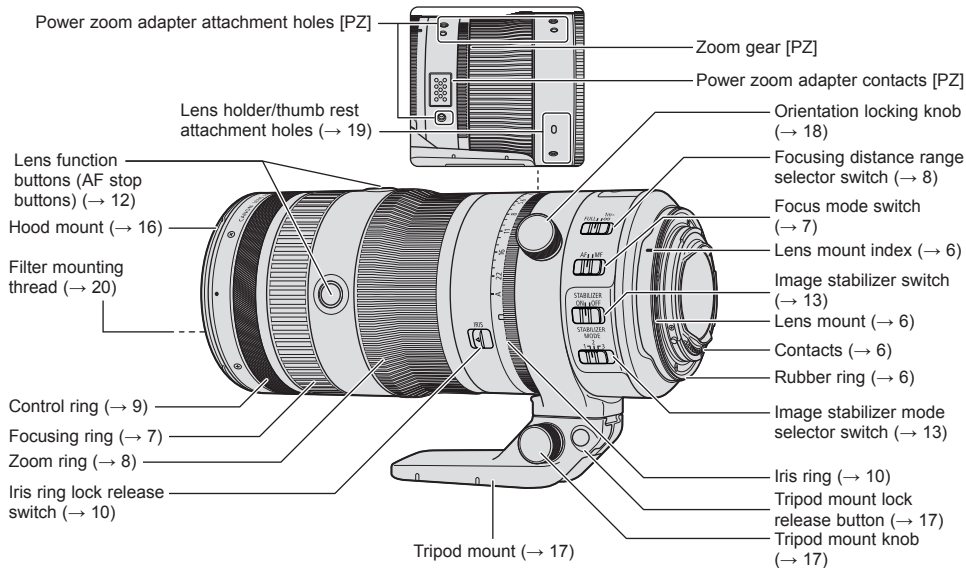

- For detailed information, reference page numbers are provided in parentheses (→ **).
- [PZ] is a part related to the attachment of the Power Zoom Adapter (for reference, see p.20).

1. Attaching and Detaching the Lens

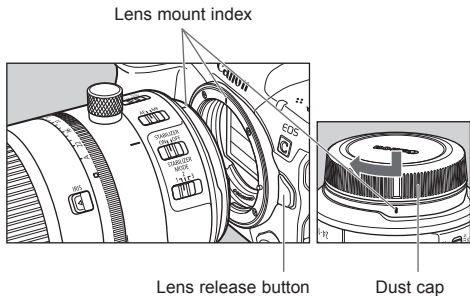

Attaching the Lens

Align the lens mount indexes of the lens and camera, and turn the lens clockwise until you hear a click.

Detaching the Lens

Turn the lens counterclockwise while pressing the camera's lens release button. Detach the lens once it has stopped turning.

Please refer to the camera's instructions for details.

- Set the camera's power switch to OFF when attaching or detaching the lens.
- After detaching the lens, place the lens with the rear end up and attach the dust cap to prevent the lens surface and contacts from getting scratched. Make sure the lens and dust cap mount indexes are aligned when attaching the dust cap.
- Contacts that are scratched, soiled, or have fingerprints on them may result in faulty connections or corrosion, which may lead to malfunctions. If the contacts get soiled, clean them with a soft cloth.
- The lens mount has a rubber ring to improve dust-resistance and water-resistance performance. This rubber ring may cause friction marks to appear around the camera's lens mount, although this will have no effect on usage.



- Rubber rings can be replaced at a Canon Service Center. (chargeable)

2. Setting the Focus Mode

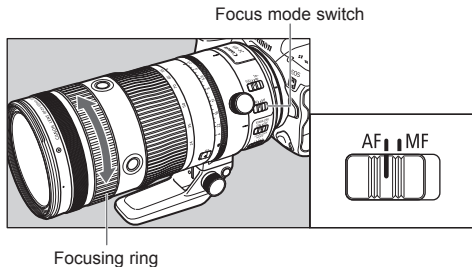

To shoot in autofocus (AF) mode, set the focus mode switch to AF.

To use only manual focusing (MF), set the focus mode switch to MF, and focus by turning the focusing ring.



- Quickly turning the focusing ring may result in delayed focus.



- The lens' focusing ring is electronic.
- With a camera capable of electronic full-time manual focus, manual focusing is always possible while the camera is operable. However, this requires a change in camera settings.
- When AF operation is set to One-Shot AF, manual focus is possible after autofocusing has been completed by continuing to press the shutter button halfway (electronic manual focus function). However, this requires a change in camera settings.
- When movie recording, the AF speed will be slower than the still photo shooting mode. It is possible to adjust the AF speed on the camera by setting Movie Servo AF to [Enable].

Please refer to the camera's instructions for details.

3. Setting the Focusing Distance Range

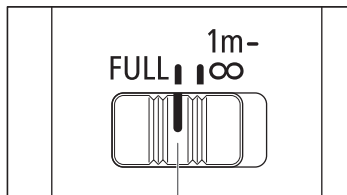

Focusing distance range selector switch

You can set the focusing distance range with a switch. By setting a suitable focusing distance range, the lens is prevented from focusing on a subject at an unintended distance.

Focusing distance range

- ① FULL (0.45m-∞)
- ② 1m-∞

4. Zooming

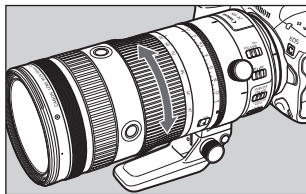

To zoom, turn the lens' zoom ring.



- Be sure to finish zooming before focusing. Zooming after focusing can affect the focus.
- Blurring may temporarily occur if the zoom ring is quickly turned.

5. Control Ring

The control ring can be assigned the functions that are commonly used with cameras, such as shutter speed and aperture settings.

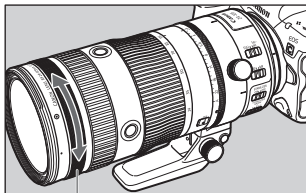

Control ring

The click action of the control ring allows you to have a sense of how much it is being turned. Please refer to the camera's instructions for details on how to use the control ring.

● There are cases in which the sound of control ring operations may be recorded when shooting movies.

- The clicking sensation of the control ring can be removed by the Canon Service Center. (chargeable)
- The focus ring can be used as the control ring by changing the camera settings*. However, when the focus ring is used as the control ring, the original control ring operation will be disabled. Please refer to the camera's instructions for details.

* Excluding EOS R, RP, Ra, R5, R5C, and R6.

6. Manual/ Auto Aperture Operation

The aperture value can be set using the iris ring. At the time of shipment, it is set to auto aperture operation.

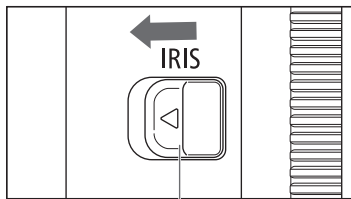

Iris ring lock release switch

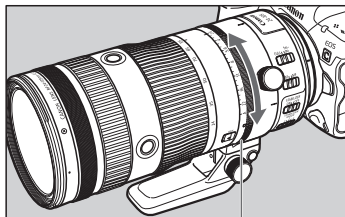

Iris ring

Manual aperture operation

- 1 While sliding the iris ring lock release switch in the direction of the arrow, turn the iris ring to match the index between 2.8 and 22.
- 2 Turn the iris ring to set the aperture.

Auto aperture operation

- 1 While sliding the iris ring lock release switch in the direction of the arrow, turn the iris ring to match the index with A.
- 2 Aperture is determined by the command signal from the camera.

Manual/ Auto Aperture Operation



- For manual aperture operation with the Iris Ring and when shooting movies, the aperture value changes in 1/32 steps, regardless of the camera settings. Consequently, the actual aperture value when shooting movies may vary from the aperture value displayed on the camera.
 - Some cameras *1 *2, have the following limitations.
 - The iris ring cannot be used to set the aperture value when shooting still images.
 - During movie shooting, when using the iris ring operation, focusing on a subject by autofocus may be difficult. In addition, the aperture value displayed on the camera may differ from the actual aperture value.
- *1 EOS R, RP, Ra, R3, R5, R6, R6 Mark II, R7, R8, R10, R50, R100
*2 EOS R5C is limited only when shooting still images.

7. Lens Function Buttons (AF Stop Buttons)

In the default settings, the lens function button serves as a AF stop button. You can assign different functions to the button from the [Customize buttons] section of the camera. Please refer to the camera's instructions for details.

Lens function buttons (AF stop buttons)

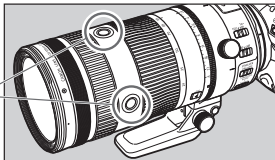

Use as a AF stop button

During autofocus operation, you can press an AF stop button to temporarily pause autofocus, and then release the button to resume.

Press an AF stop button to maintain a focusing distance or to avoid focus search.

Press the shutter button while holding down an AF stop button to shoot at that focusing distance.

- Useful when autofocus is operating mostly in Servo AF.

8. Image Stabilizer

Image stabilization corrects vibrations that occurs with hand-held shots.

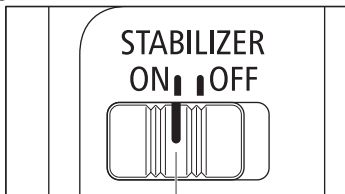

Image stabilizer switch

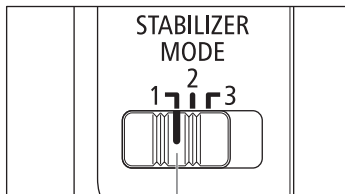

Image stabilizer mode selector switch

- 1 Set the STABILIZER switch to ON.
 - The Image Stabilizer will work in combination with cameras with in-body Image Stabilizer.
 - If you are not going to use image stabilization, set the image stabilizer switch to OFF.
- 2 Select an Image Stabilizer mode according to the application and shooting conditions.

Image Stabilizer modes

- MODE 1: Corrects vibrations in all directions. It is suited to shooting still subjects.
- MODE 2: When you take a panning shot either horizontally or vertically, corrects vibrations at right angles to the direction of panning. It is suited to shooting moving subjects.
- MODE 3: During exposure, corrects vibrations in the same way as MODE 2. Since vibration is corrected only during exposure, It is suited to shooting irregularly moving subjects.

Image Stabilizer

The Image Stabilizer for this lens is suited to hand-held shots in the following conditions.

MODE 1

Shooting still subjects



- In semi-darkened areas such as indoors or outdoors at night.
- In locations where a flash cannot be used, such as art museums and theater stages.
- In situations where your footing is uncertain.
- In situations where fast shutter speed settings cannot be used.

MODE 2

Shooting moving subjects



- Panning shots of vehicles, trains, etc.

MODE 3

Shooting irregularly moving subjects



- Sports photography of soccer, basketball, etc.
- Photography of animals

Image Stabilizer

- The Image Stabilizer cannot compensate for a blurred shot caused by a subject that moved.
- The Image Stabilizer might not be fully effective in the following conditions:
 - Large shake or fast vibration
 - Panning in MODE 1
- When using a tripod, the Image Stabilizer might not be fully effective or it might be better to set the STABILIZER switch to OFF, depending on the type of tripod and where the tripod is located, as well as on the camera's settings such as shutter speed.
- Although image stabilization will operate when using a monopod, depending on the shooting conditions, sometimes the Image Stabilizer might not be fully effective.
- When movie recording, operation of the Image Stabilizer will differ.
 - For cameras with in-body Image Stabilizer, vibrations are corrected in all directions, regardless of the Image Stabilizer mode selected.
 - For cameras without in-body Image Stabilizer, the Image Stabilizer will not work when the Image Stabilizer mode is set to MODE 3.

9. Hood

The custom lens hood reduces unwanted light that causes flare and ghosting and protects the front of the lens from rain, snow, and dust.

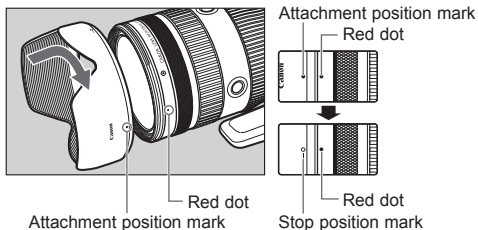

Attaching the Hood

Align the red attachment position mark on the hood with the red dot on the front of the lens, and then turn the hood in the direction of the arrow until you hear a click.

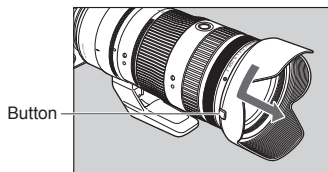

Detaching the Hood

Keep your finger pressed down on the button located on the side of the hood, and then turn the hood in the direction of the arrow until the attachment position mark on the hood is aligned with the red dot on the front of the lens to detach it.

The hood can be reverse-mounted on the lens for storage.



- If the hood is not attached properly, vignetting (darkening of the perimeter of the picture) may occur.
- Grasp and turn the base of the hood when attaching and detaching it. There are cases in which it may become deformed if the hood is turned with it grasped near to the rim.

10. Using the Tripod Mount

A tripod or monopod attaches to the tripod mount on the lens.

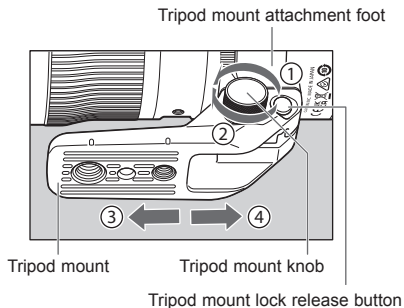

Detaching the Tripod Mount

- 1 Rotate the tripod mount knob in the direction indicated by arrow ①.
- 2 While pressing the tripod mount lock release button, slide the tripod mount in the direction of arrow ③ to remove it.

Attaching the Tripod Mount

- 1 Slide the tripod mount in the direction indicated by arrow ④ until you hear a click.
- 2 Rotate the tripod mount knob in the direction indicated by arrow ② until it stops moving. Once the tripod mount knob stops moving, please attempt to firmly tighten it again.



- When attaching the tripod mount, firmly tighten the tripod mount knob so that the tripod mount is mounted securely to the lens. The lens may fall from the tripod mount if the tripod mount knob is not fully tightened.
- Not attaching the tripod mount securely may result in blurred images even when using a tripod or monopod during shooting.
- Please attach the tripod mount in the direction as shown in the illustration. It is not possible to attach the tripod mount while positioned in any other direction.

Using the Tripod Mount

Adjusting the Tripod Mount

By loosening the orientation locking knob, you can rotate the camera to set the image for any vertical or horizontal position.

11. Lens holder LH-E1 (sold separately)

For stable shooting, using the Canon lens holder LH-E1 (sold separately) attached to the lens and fixed to the rig (rod) is recommended.

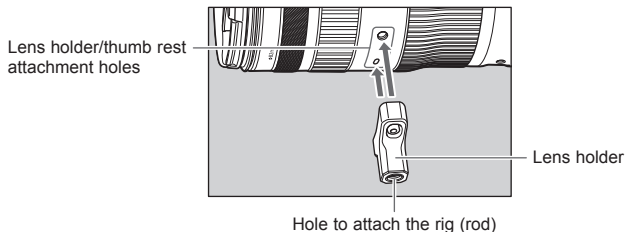

Attaching the lens holder

- 1 Use the hex key to attach the lens holder to the lens holder/thumb rest attachment holes.
- 2 Attach the lens to the camera.
- 3 Attach the commercially available rig (rod) to the rig (rod) attachment hole of the lens holder. For procedures to attach the rig (rod), refer to the operation manual of the rig (rod).
 - Remove the lens holder by performing the procedures in the reverse order.

- Be sure to remove the lens from the camera before attaching or detaching the lens holder to the lens.

12. Filters (Sold separately)

You can attach filters (ø82) to the filter mounting thread on the front of the lens.

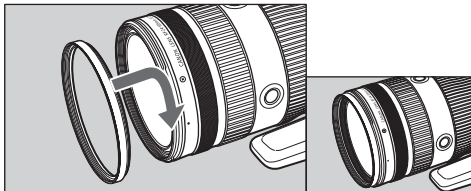

- Only one filter may be attached.
- Detach the hood when adjusting the polarizing filter.

13. POWER ZOOM ADAPTER (sold separately)

The Power Zoom Adapter PZ-E2, PZ-E2B can be attached to this lens in order to perform motorized zooming. Refer to the PZ-E2, PZ-E2B instruction manual for details on use.

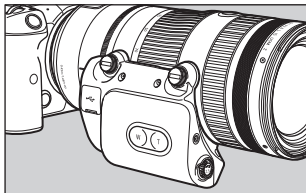

Specifications

Focal Length/Aperture	24-105mm f/2.8
Lens Construction	18 groups, 23 elements
Maximum Aperture	f/2.8
Minimum Aperture	f/22
Angle of View	Horizontal: 74° - 19°20', Vertical: 53° - 13°, Diagonal: 84° - 23°20'
Min. Focusing Distance	0.45 m/1.48 ft.
Max. Magnification	0.29x (at 105 mm)
Field of View	Approx. 408 x 272 mm/16.06 x 10.71 in. (at 24 mm, 0.45 m/1.48 ft.) Approx. 121 x 80 mm/4.76 x 3.15 in. (at 105 mm, 0.45 m/1.48 ft.)
Filter Diameter	82 mm
Max. Diameter and Length	Approx. 88.5 x 199 mm/3.48 x 7.83 in.
Weight	Approx. 1330 g/46.91 oz.
Hood	EW-88E*
Lens Cap	E-82 II*
Lens Dust Cap	Lens Dust Cap RF*
Case	LZ1326(B)*

* Included with the lens, but can be purchased separately.

Specifications

- The lens length is measured from the lens mount surface to the front end of the lens.
Add 24 mm/0.94 in. when including the lens cap and dust cap.
- The maximum diameter, length and weight listed are for the lens itself only.
- Close-up Lens 250D/500D cannot be attached because there is no size that fits the lens.
- You cannot use extenders.
- Multiple exposure shooting is not possible when using this lens on certain cameras*.
* EOS R, RP, Ra, R5, R5C, R6
- All data listed is measured according to Canon standards.
- Product specifications and appearance are subject to change without notice.

Canon